

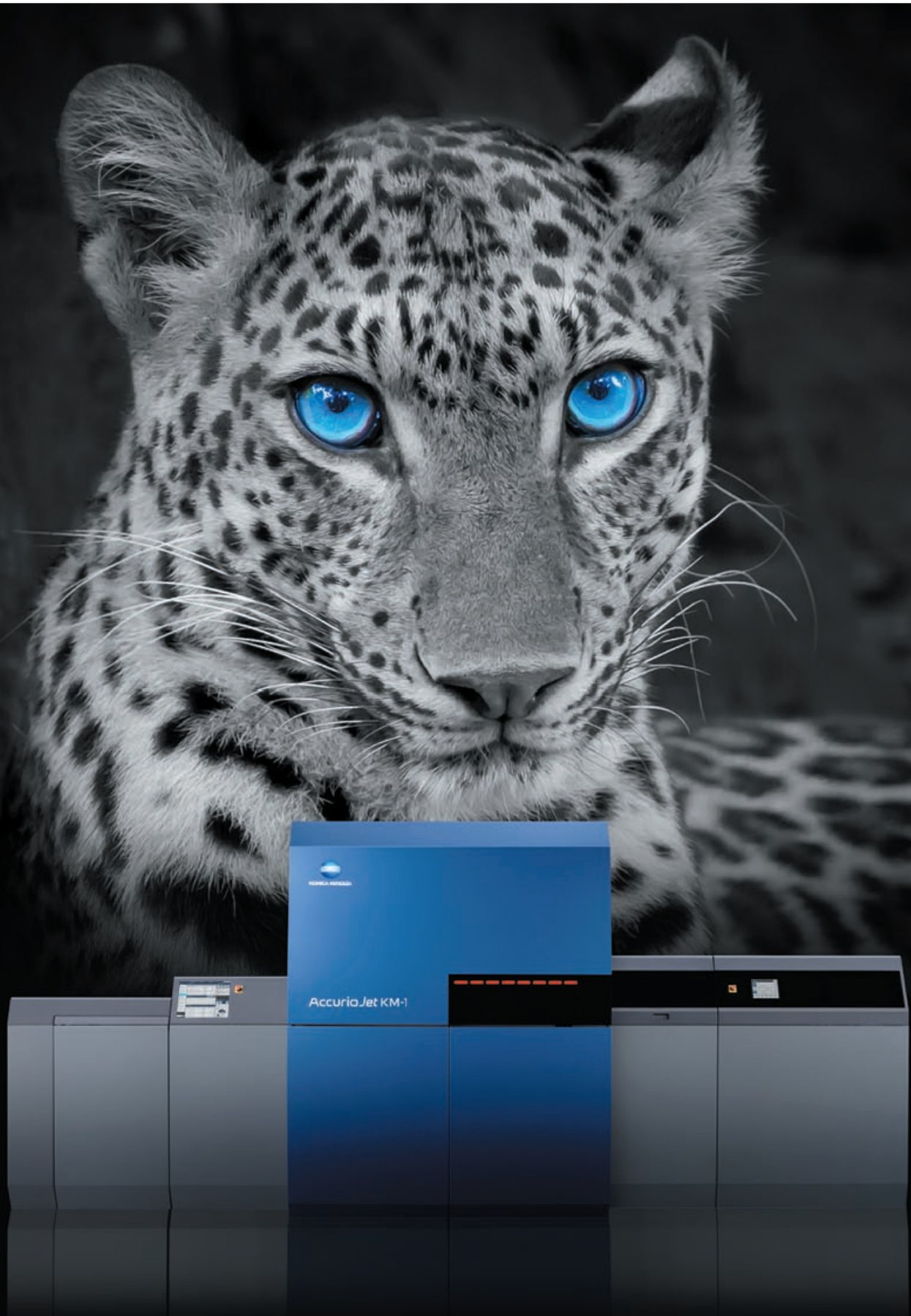

KONICA MINOLTA

29-inch Sheet-fed UV Inkjet Press

AccurioJet KM-1



Giving Shape to Ideas

Superb paper-compatibility and productivity
Compatible with hybrid workflows
The outstanding image quality and reliability
open up the possibilities of
new printing services.



Combination of Konica Minolta's Technologies and Know-how

Based on technologies it has amassed from its creation of digital printing, Konica Minolta has developed AccurioJet KM-1, a press that incorporates a new UV ink, high-performance inkjet print heads and system processing technologies. Applying these proprietary technologies, Konica Minolta has realised "high image quality", "Flexibility", "stability" and "high productivity" essential to the functions of a production machine.

The superb functions and reliability of AccurioJet KM-1 offers new merits such as "the creation of new business", "strengthening of relationships with clients" and "rationalisation of production processes and business".



Konica Minolta
29 inch sheet-fed UV inkjet press

AccurioJet KM-1

Inkjet Print Heads

AccurioJet KM-1 is furnished with a print bar mounted with an alignment of newly-developed high-definition high-frequency print heads. The single-pass system realises high-speed output of 3,000 sheets/hour at an high image quality of 1200dpi. Parts can be replaced by the operator, contributing to improved productivity by cutting down time for service engineers to arrive.

LED UV Array

Ink is cured instantaneously by UV light using long-life ozone-free LEDs.

Inline Sensor

Inline sensor detects nozzle misfire or streaks and automatically correct the image to ensure high and stable image quality.

Paper Ejector

Large-volume paper ejection is possible up to height of 630mm. A sampling tray is also available.

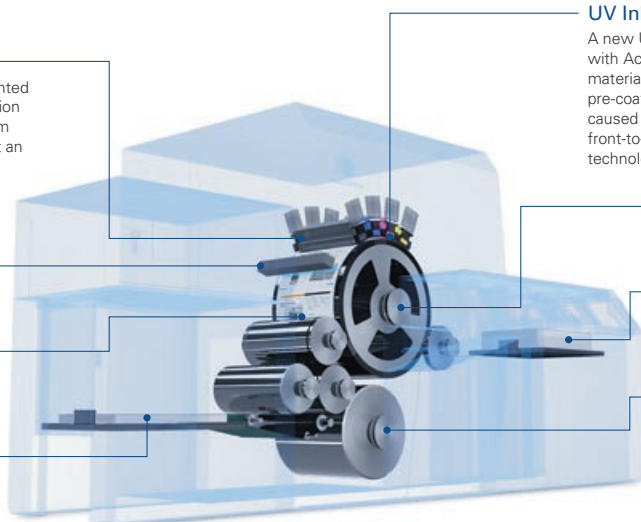

UV Ink

A new UV ink has been developed exclusively for use with AccurioJet KM-1. Printing of a wide range of base materials including offset paper is possible with no pre-coating. Light-cured UV ink avoids paper problems caused by heat drying, and provides high accuracy of front-to-back registration. In addition, our original technologies enable realisation of a natural gloss finish.

Main Cylinder

Grip to grip technology ensure highly-accurate paper transportation.

Paper Feeder

The same feeding system as offset press ensures reliable paper feeding. The paper feed capacity is up to height of 900mm.

Automatic duplex printing

A maximum of 1,500 sheets/hour can be output in the duplex printing mode. Duplex printing capability with a compact machine design is a major merit that can be realised only by a UV inkjet system that requires no drying process.

High Quality

Like the overwhelming beauty of a peacock with its tail feathers spread.

Newly-designed inkjet print head and newly-developed UV ink. Applying its amassed image processing technologies, Konica Minolta has realised image-quality close to offset printing.



■ 1200x1200dpi High Image Quality

Konica Minolta's newly-developed cutting-edge inkjet print head, newly-developed UV ink and half-tone processing, all dedicated for superb quality enables the achievement of 1200dpi high image quality.

■ Sharp Text Quality

Konica Minolta's original proprietary font edge-processing technology enables the realisation of excellent text quality with sharpness and legibility even for small font sizes.

■ Natural Gloss Finish

Our newly-developed UV ink cuts down on degradation of gloss or texture caused by ink depth variations, a problem with conventional UV inks, to realise a natural gloss finish.

■ Optimised Ink Volume to match Paper and Printing Objectives

Paper-compatible output profile settings and three output modes make it possible to adjust image quality to match the paper type, printing objective, image quality and printing costs.



■ **High-precision Colour-matching Technology**

AccurioJet KM-1 incorporates the high-precision colour-matching technology used in the AccurioPress Series.

■ **Wide Colour Gamut**

The newly-developed UV ink covers the Japoncolor ink gamut.



Konica Minolta
Inkjet Print Head Module capable of
producing high image quality of 1200dpi

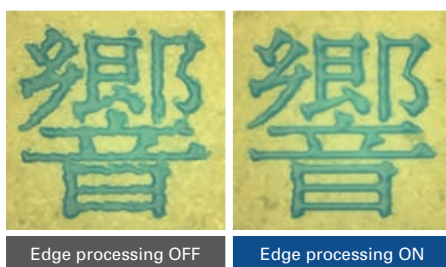

Improved character quality by application
of edge-processing technology

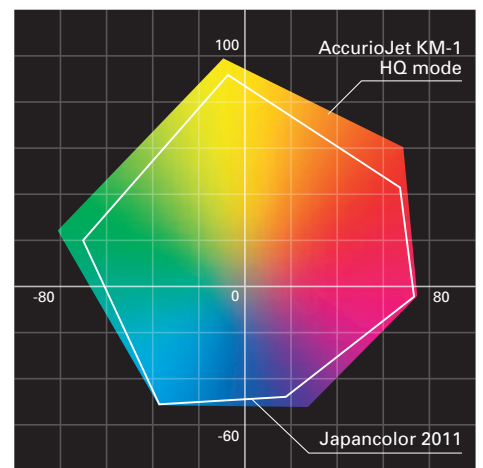

AccurioJet KM-1 colour gamut that covers
Japoncolor



■ High Productivity of 3,000 sheets/hour

AccurioJet KM-1 is capable of output of 3,000 sheets/hour of the maximum paper size (585x750mm) and also offers impressive job-peak performance at a productivity rate of 1,500 sheets/hour in the automatic duplex printing mode. AccurioJet KM-1 can achieve even higher per-job productivity with jobs in which the number of impositions can be increased by using a large size paper.

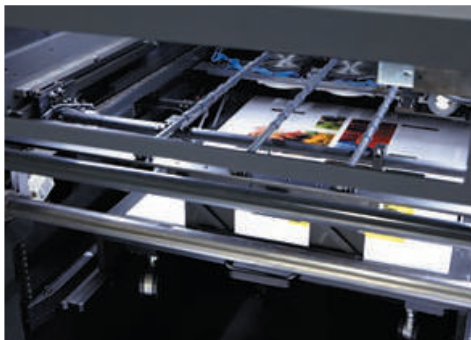

High speed printing at rates of 3,000 sheets/hour for simplex printing and 1,500 sheets/hour for automatic duplex printing

■ Automatic duplex printing with no drying time

Use of the new UV ink eliminates the need for drying time. AccurioJet KM-1 is capable of automatic duplex printing not possible with conventional inks. Elimination of time spent waiting for ink to dry contributes significantly to reduction in the overall production time.



Automatic duplex function essential to realisation of short turnaround time



High Productivity & Short Turnaround

Like a panther racing towards its prey with unrivalled explosive power

AccurioJet KM-1 contributes to short turnaround time not only through fast printing speed, but also features such as reduced drying time by use of UV ink and unfailing reduced downtime thanks to the user-maintenance design.

■ No need for printing plates and major reduction in printing preparation time spent on colour adjustments

In addition to flexibility realised by the elimination of the need for printing plates, as a digital printer, AccurioJet KM-1 makes it possible to achieve major reductions in preparation time. In addition, because it is capable of high productivity as a digital printer, major reductions in printing preparation time can be realised because there is no need to perform tasks such as a colour adjustment between machines required in situations where multiple digital printers are in use.

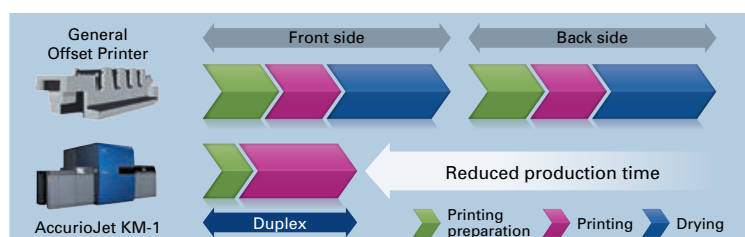

Automatic duplex printing without the need for printing plate and drying process contributes to significant reduction in production time.

■ Machine Design that minimises downtime

Like an offset printer, the machine has been designed so that it can be maintained by the operator in most cases. This means reduced downtime caused by visits of service engineers, contributing to improved operating ratio.



Maintenance mode

Flexibility & Versatility

Like an eagle that uses its sharp eyesight to focus on its prey

Furnished with the ability to handle a wide variety of paper types, AccurioJet KM-1 makes major contributions to printing services. Compatible with the largest paper size in the class and a wide range of types from thin to thick papers, AccurioJet KM-1 offers the ability to use an extensive range of base materials including offset paper with no need for pre-processing. AccurioJet KM-1 takes maximum advantage of the range of digital-printing applications including the inimitable merit of non-contact UV inkjets that allow handling rough surface paper to create new business.



■ Maximum paper size of 585x750mm

Compatible with 585x750mm paper size larger than the standard B2. AccurioJet KM-1 significantly expands the range of paper usage and enables improved productivity by increasing the number of impositions.

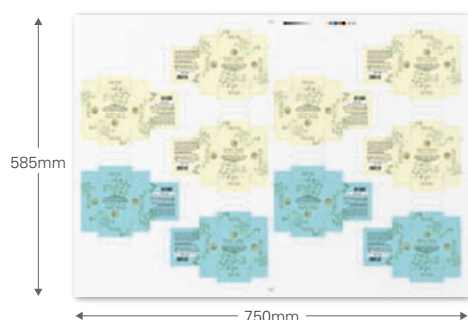

The ability to increase the number of impositions of small size prints enables improved productivity and workability.

■ Compatibility with diverse paper types through the elimination of the need for pre-processing

No exclusive paper types are required. Because no pre-processing such as pre-coating is required, AccurioJet KM-1 is capable of handling a wide range of base materials including ordinary offset printing paper, significantly contributing not only to enhanced paper-compatibility, but also short turnaround time through elimination of the need for warehousing and reduced number of production processes.



Printing of posters of a maximum size of 585x750mm

Capable of printing book jackets, tri- and quad-fold menus, brochures and pamphlets. AccurioJet KM-1 offers improved workability achievable by the automatic duplex printing function.





■ **Compatible with paper thickness of 0.06 to 0.6mm**

Compatible with paper thicknesses from 0.06mm to 0.6mm. Not only ordinary printing, but also applications such as package printing can be performed on a single machine. In addition, paper thicknesses of 0.06mm to 0.45mm can be handled in the automatic duplex printing mode.



Compatible with a wide range of paper thicknesses from 0.06mm to 0.6mm and also capable of handling applications that require strength.

■ **Compatible with texture paper using the UV Inkjet system**

The ability to print on texture paper, a task that presents difficulties with offset or electro-photographic printing systems, is one of the unique merits of the UV inkjet system, a non-contact system that cures without the need for pre-processing. This wide-ranging compatibility offers the ability to further improve designability and create new added values.



Outstanding printing quality on texture paper using the UV Inkjet System

■ **Variable printing compatibility unique to digital printing**

The controller developed by Konica Minolta enables variable printing, enabling the provision of new printing services to contribute to business expansion by improving customer relations and winning new jobs.



■ **Paper-conveying technology identical to that used in Offset Printing**

AccurioJet KM-1 incorporates paper-conveying technology identical to that used for offset printers to realise highly reliable and accurate paper conveyance.

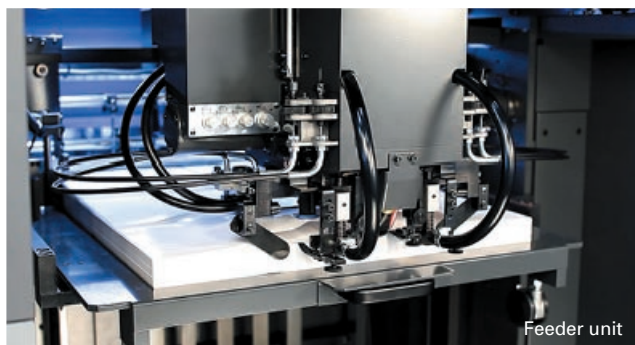

Feeder unit

■ **Greater registration accuracy realised by use of UV ink**

The use of UV ink eliminates problems such as waviness or curling commonly occurring during processes such as thermal fixing and drying to achieve superb print quality and highly-accurate registration.

■ **Stable printing quality**

Because UV ink does not readily dry when exposed to air, problems such as ejection misalignment caused by drying of the ink on nozzle surfaces are minimal compared to other inkjet systems.

■ **Image quality control by inline sensor**

AccurioJet KM-1 is equipped with internal inline sensor that automatically detect and correct image flaws. The inline sensor keep image quality degradation caused by nozzle defects in the inkjet system to a minimum.



Reliability

Like a lion winning the unshakeable trust of his subjects as king of animals

Reliably produces printed products of stable high quality. AccurioJet KM-1 uses paper conveying technology identical to that in an offset printer to ensure reliable and stable paper handling. In addition, the use of UV ink ensures highly-accurate registration and minimal nozzle clogging to deliver stable image quality.



Problems such as nozzle misfire and streaks are detected and images automatically corrected by inline sensors.

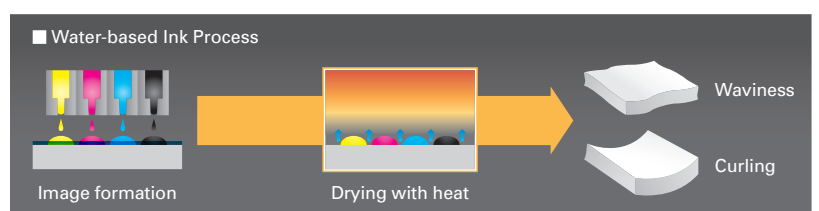
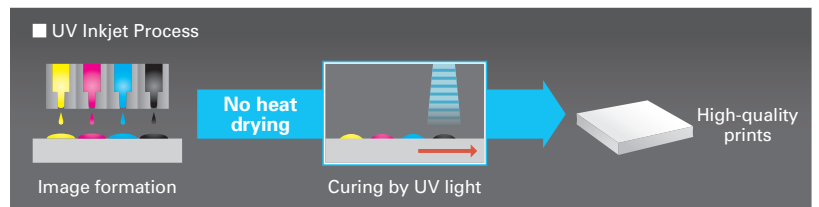

Merits of using UV ink. Because processes such as permeation of the paper with solvents and drying are unnecessary, paper waviness is minimised and outstanding registration accuracy and high quality prints are realised.

AccurioJet KM-1 29-inch Sheet-fed UV Inkjet Press

Assumed operational workflow

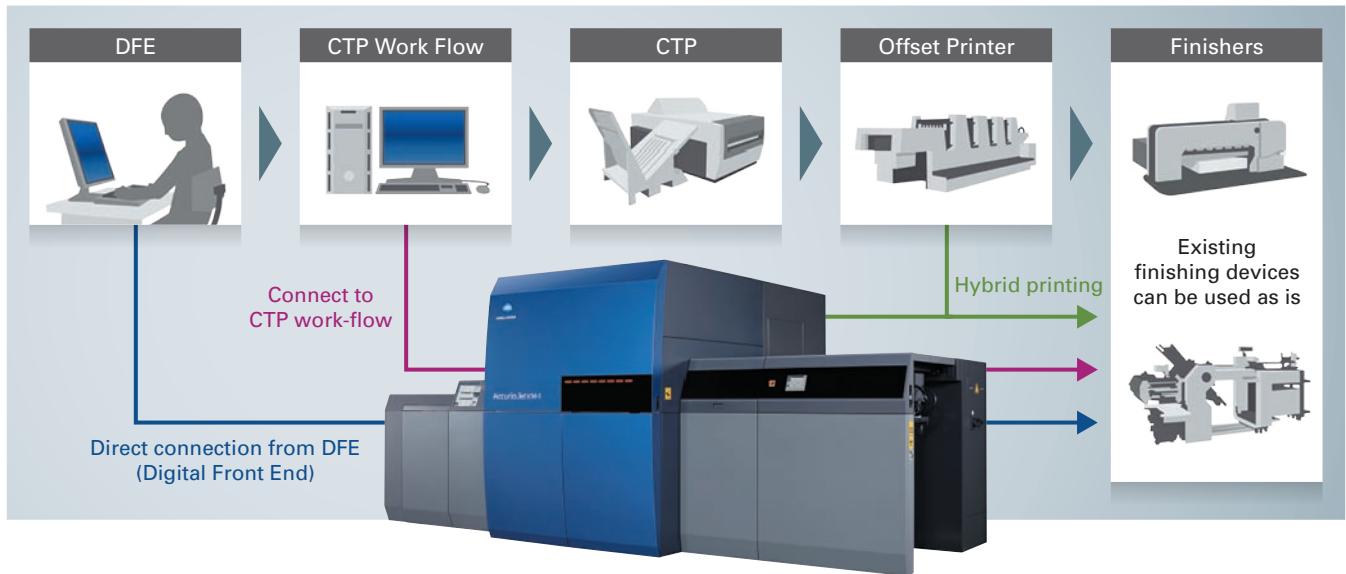

Major Specifications

Type	29-inch Sheet-fed UV Inkjet Press
Resolution	1,200 x 1,200dpi
Ink	UV ink
Colour gamut	4 colours
Printing speed	Simplex printing: 3,000 sheets/hour Duplex printing: 1,500 sheets/hour
Max. paper size	585 x 750mm
Max. printing size	Simplex printing: 575 x 735mm Duplex printing: 575 x 730mm
Paper thickness	Simplex printing: 0.06 to 0.6mm Duplex printing: 0.06 to 0.45mm
Device dimensions (W x D x H)	5,369 x 2,947 x 2,325mm
Device weight (main body)	Approx. 8,100kg

*Specifications and functions listed in this catalog are subject to change without notice.

AccurioJet KM-1 Partners



Alwan Color Expertise
A worldwide leader in color management, standardisation and process control software.



Harris & Bruno International
A global provider of high performance printing & coating equipment.



ITOTEC Co., LTD.
The cutting machine maker with a near-100-year history of business experience.



Opensoft Inc.
Scissor Hands is an excellent artificial intelligence has brought evolution to cutting work. DaVinciDesigner is an online print 3D proofer for special embossed finishes and textures.



Rollem International
Provides rotary slitting, scoring, perforating collating and delivery systems plus the Insignia line of die cutting solutions.



Tharstern Limited
A market leading software company providing Management Information Systems to the printing, packaging and label industries.



Ultimate TechnoGraphics Inc.
Ultimate develops and distributes cutting edge technology to automate and facilitate imposition and finishing for the graphic arts industry.

Product appearance, configuration and/or specifications are subject to change without notice. This product is not available for some countries or regions.

KONICA MINOLTA, the KONICA MINOLTA logo, symbol mark, Giving Shape to Ideas, AccurioPress, Accuriojet, AccurioPro, and their respective logos are registered trademarks or trademarks of KONICA MINOLTA, INC. All other brands and product names are registered trademarks or trademarks of their respective companies or organisations.

Requirements for safe use

- Please read and follow the instruction manual to ensure safe operation.
- Only operate using appropriate power supply and voltage.
- Connecting the earth wire to an inappropriate place may cause explosion or electric shock. Please connect accordingly (Taiwan and the Philippines only).

KONICA MINOLTA, INC.
2-7-2 Marunouchi Chiyoda-ku, Tokyo, Japan
<http://www.biz.konicaminolta.com>