

KONICA MINOLTA

AccurioPress
C4070

BUILD YOUR BRIDGE TO SUCCESS

RETHINK VERSATILITY

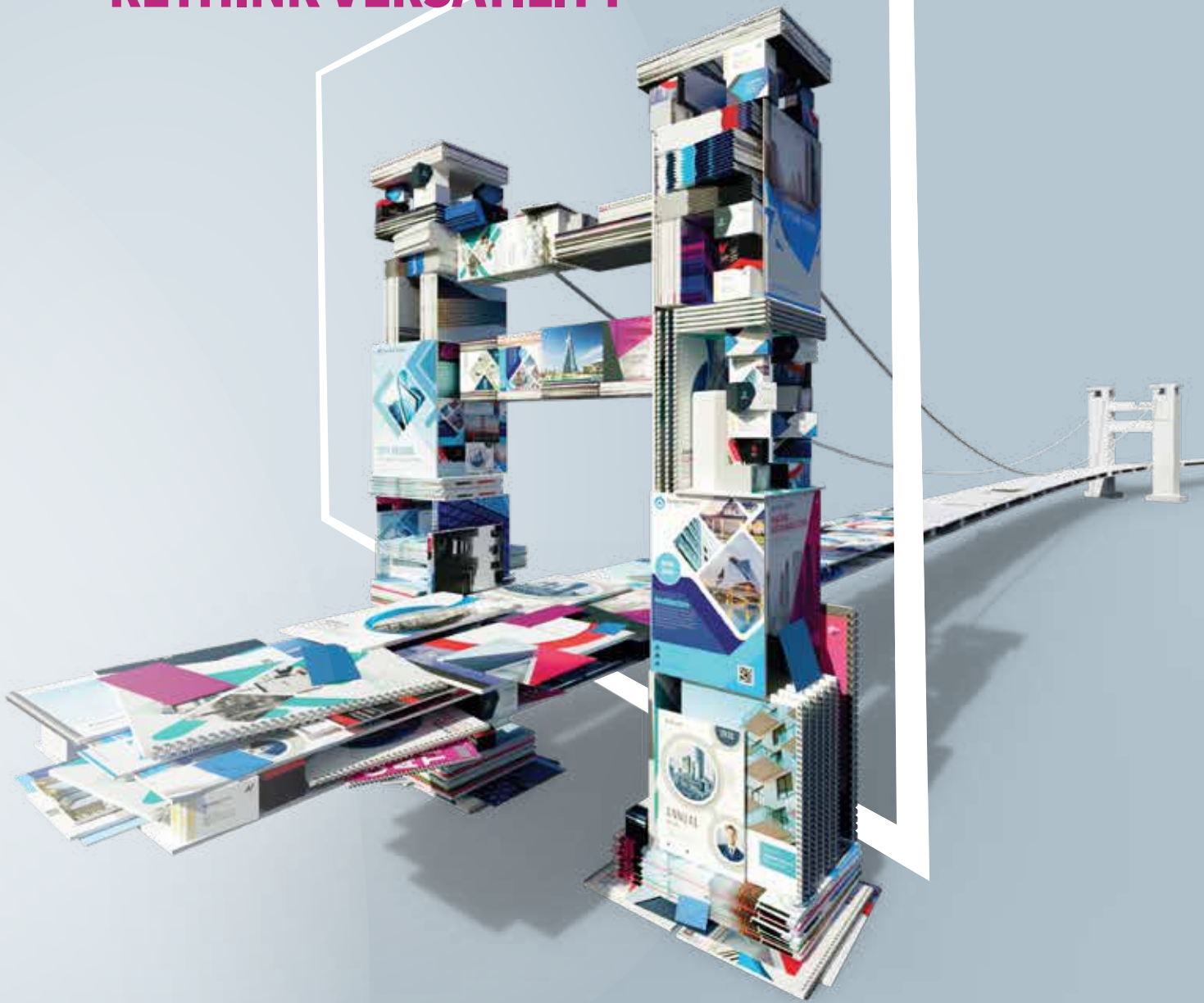

Giving Shape to Ideas

BE CREATIVE

RETHINK GRAPHIC COMMUNICATION

Imagine having just a single press that is good for everything: 2-sided banner printing, professional inline finishing, highest productivity, real-time automated quality adjustments, excellent print quality, and so much more. That's the AccurioPress C4070 from Konica Minolta for you: our agile production colour press with features that enables you to expand your business into new markets and develop new revenue streams.

Exceptional quality, every print

Exclusive Intelligent Quality Optimizer IQ-501 leverages Konica Minolta's long history of brilliant imaging technology, allowing you to wow your customers with stunning consistent colour prints time and time again.

A single engine does it all

The AccurioPress C4070 is a fully configured press to expand your business as you wish. You can print flat sheets, duplex long sheets of up to 864 mm, or directly finish prints inline with our extensive choice of finishing options to meet your clients' every need in one integrated production process.

Grow your business

The AccurioPress C4070 expands your business with new capabilities. Our system offers the biggest media variety in the market, from thin to thick paper, embossed paper, envelopes and many more. All supported by our new optional media sensor to guarantee worry-free operation.

Boost efficiency

Operators of any AccurioPress system can count on simple setup, an ultra-reliable paper path, exceptional productivity and outstanding automated image stability. Our R&D Team has given highest priority to fulfilling today's high demands in the printing industry. What's more, the AccurioPress system seamlessly integrates into various software applications from our portfolio that will make your business more economic.

10 GOOD REASONS FOR AccurioPress C4070



1. SIMPLY EFFICIENT

with Intelligent Media Sensor, Intelligent Quality Optimizer and many unique inline finishing options.



2. PERFECT IMAGE QUALITY

with Konica Minolta's very own Imaging Technology and Toner development.



3. ENHANCE YOUR RANGE OF PRINT OFFERINGS

and fulfill today's demands for versatile and creative print products.



4. OUTSTANDING PAPER COMPATIBILITY

Media up to 360 gsm. Excellent versatility with class leading banner printing, envelop printing and texture printing capabilities.



5. SEAMLESS INTEGRATION

into Konica Minolta's application portfolio.

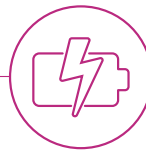

6. VERSATILITE CONFIGURATIONS

over 200 possibilities to configure your own press.



7. SHORT TURNAROUNDS

with automated quality control and inspection on the fly.



8. LOW LEARNING CURVES

Precise colour matching, even for novice operators, avoids or at least minimises learning curves



9. BENEFIT FROM GREAT BUILT-IN TECHNOLOGIES

e.g. the latest screening and registration technologies.



10. HIGH OUTPUT EVEN WITHOUT SKILLS

by improved technologies.

YOUR ADVANTAGES WITH THE AccurioPress C4070

RETHINK PRODUCTION PRINTING

READY-MADE PRINT PRODUCTS

- 50-sheet booklet making with front trimming and optional creasing, slitting and spine corner forming
- Perfect binding for books of up to 30 mm
- Automated inline business card and postcard cutting
- Full bleed banners, A3 and A4 posters

DURABLE PERFORMANCE

- Up to 71 A4 colour pages per minute
- Up to 39 A3 colour pages per minute



HIGHEST RELIABILITY

- Long-life platform, long-lasting parts and consumables
- Accurate front to back registration
- Fusing-rolling mechanism

HIGH-END PRINT CONTROL

- Flexible choice of controller technology: EFI® or proprietary Konica Minolta controller
- Integration into hybrid workflows

EASE OF USE

- Automated real-time engine calibration
- Simple paper catalogue settings
- Open API/IWS support

SOPHISTICATED MEDIA HANDLING

- Air suction or air-assisted paper feeding technology
- Up to 11 paper trays
- Long sheet printing of up to 1300mm (simplex), 864mm (duplex)

COMPREHENSIVE MEDIA PROCESSING

- Up to 360gsm paper weight in simplex and duplex
- Envelope print function as standard
- Optional media sensor estimates paper weight and type

SIMPLY EFFICIENT

- Automated engine linearisation
- Automated duplex registration
- Automated profiling
- Real-time adjustments
- Purge function

PERFECT IMAGE QUALITY

- S.E.A.D. V technology and 3,600 x 2,400 dpi x 8 bit resolution
- Simitri HDe toner technology
- Image density control technology

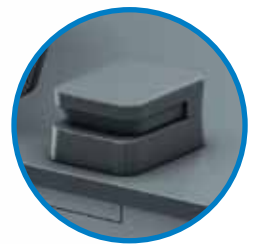

FINISHING & FUNCTIONS

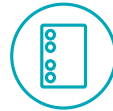

2/4 hole Punching



Two-point stapling



Corner stapling



Stacking

Open stacker OT-512					
Staple finisher FS-532m					
Folding and punching unit FD-503					
Perfect binding unit PB-503					
Booklet making unit SD-506					
Trimming unit TU-510					

NEW TRIMMING UNIT - TU-510

Trimmer unit TU-510, which can trim in all four directions, is now available. A slit unit (for cutting sheets in the travel direction) and a cut unit (for cutting sheets in the cross direction) are installed as standard

The main functions are as follows:

- Four-side trimming
- Business card/card size cutting
- Creasing
- SRA3 paper to 2 A4 papers

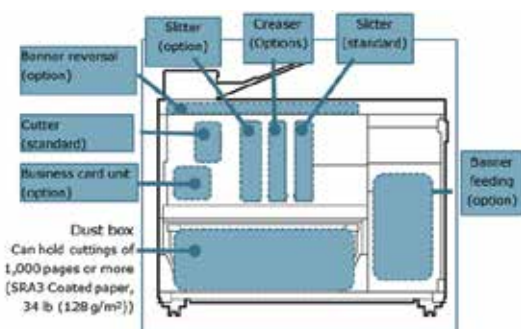

PERFECT BINDING UNIT PB-503

- Hot melt glue binding system
- Books from A5 up to A4+ (307 x 221 mm)
- Books from 10 sheets up to 30 mm spine width
- Simplex and duplex printing of covers and its spine

STAPLE FINISHER FS-532M

























Tray	FS -532
Main Tray	4,200 sheets*
Sub Tray	300 sheets

Major functions of FS -532m (includes functions with sub-options)



*A4 paper, with SD-510 and MK-761 uninstalled

								
Booklet	Trimming	Creasing	Perfection	Slitting	Spine Corner Forming	Three-fold	Post Insertion	Perfect Binding
								
								
								
								
								

 standard  optional

STREAMLINE YOUR PRODUCTION

RETHINK YOUR WORKFLOW

Evolving from our expertise in precision technologies and more than 80 years of experience in the printing and imaging industries, AccurioPro reflects our commitment to developing market-shaping technology with functionality that enables your business to grow. AccurioPro, Konica Minolta’s suite of digital solutions for professional printing, is one of the industry’s most versatile and powerful tools to optimise print production operations and workflows.

For all printing companies looking to integrate their printing as well as businesses that use digital printing to produce their own in-house publications and promotional materials, AccurioPro boosts speed and

efficiency, expands capabilities and services, and reduces the need for operational manpower – all of which will help improve your profitability!

The comprehensive suite of features that AccurioPro offers includes centralised management, software for automated workflow processing, colour management, seamless integration of different printing technologies and full connectivity of all Konica Minolta printing systems used from input to output.

INNOVATE PRINT RETHINK TECHNOLOGY

The innovative Intelligent Quality Optimizer IQ-501 takes consistency and registration accuracy to a new level. The IQ-501 provides extensive automation for image position and registration on the one and colour control on the other hand. This is made possible with our proprietary closed-loop control system that checks and corrects printed output.

Automation provided by the IQ-501 also extends to colour calibration and profiling – all designed to reduce operator time and print wastage while increasing productivity.

S.E.A.D. X Image Processing

Konica Minolta’s own advanced colour processing technology of the fifth generation is called S.E.A.D. X, which stands for “Screen-Enhancing Active Digital Process”, and combines an array of technical innovations to guarantee truly exceptional colour reproduction at top speed.



Intelligent Media Sensor

The optional media sensor IM-101 automatically detects the type, weight, thickness and surface of each substrate, and proposes the appropriate paper settings from the catalogue, which makes wrong paper settings a thing of the past avoiding misprints and waste.

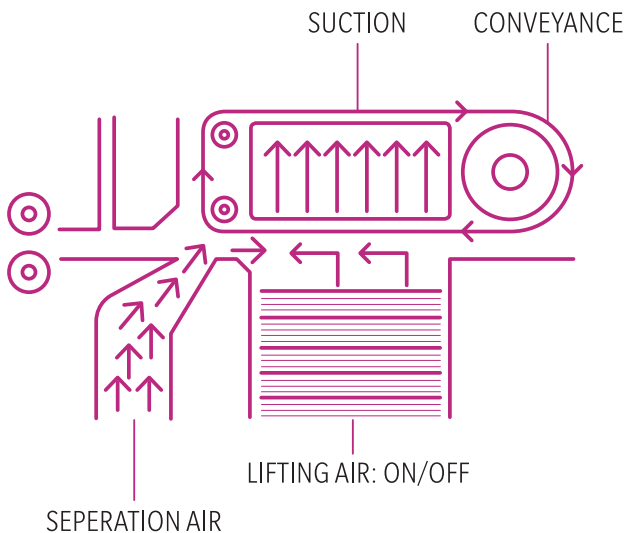

Vacuum paper feeding

It is essential for high-volume printers to feed each and every sheet smoothly and precisely through the digital press. To ensure this, Konica Minolta offers professional and intelligent paper feeding that builds upon proven concepts, including a combination of air separation of sheets and suction/ vacuum feeding. This ensures smooth paper processing throughout the printing system. For efficient printing on offset preprinted and coated stock as well as under high humidity conditions, an optional heating unit can be added to enhance this precise technology further.

STATE-OF-THE-ART PRINT SERVER

RETHINK YOUR USER EXPERIENCE

THE IC-609 KONICA MINOLTA OWN CONTROLLER

The Konica Minolta IC-609, the 16GB print controller brings powerful workflow benefits – including 2,400 dpi printing, high-speed RIP processing, enhanced accuracy in colour reproduction, colour management functions and full compatibility with print engine on-board job control and editing functions.

THE IC-317 FIERY IMAGE CONTROLLER

Providing advanced job management and workflow automation, the Fiery® IC-317 reduces labour costs, cuts turnaround times, and minimises errors as well as waste. The instant visual preview and advanced make ready capabilities streamline job layouts. Support of industry-leading variable data printing (VDP) formats facilitates the profitable production of personalised short-run jobs.

THE IC-419 INTERNAL FIERY IMAGE CONTROLLER

As the embedded Fiery® controller alternative, the IC-419 offers a combination of affordability, versatile colour management and PCL support plus a wide range of security features. It helps improve the ease of use of AccurioPress systems, and simplifies workflows so that our digital colour presses deliver truly professional print results, making any configuration an ideal business solution for your company's printing facilities.



TAKE THE LEAD AND SHOW RESPONSIBILITY

RETHINK TOMORROWS BUSINESS

Commercial printers

The AccurioPress C4070 supports you in growing your business and getting the most out of your investment. Its high speed, high productivity and high uptime help you achieve shortest turnaround times, while the great media flexibility with stocks of up to 360gsm, long sheets of up to 1300 mm, envelopes and structured media will further enhance the variety of your print offerings. Colour quality issues are a thing of the past as the AccurioPress C4070 includes numerous auto control and adjustment features. What's more, an inspection system can be applied to make sure only impeccable prints leave your shop.

CRDs

The AccurioPress C4070 provides the highest degree of automation and produces quality on the highest level. With its professional inline finishing, you can create ready-made products at the push of a button; and the Intelligent Quality Optimizer IQ-501 makes sure that the print quality is automatically set, monitored and continuously corrected. The versatile media flexibility and high productivity make the AccurioPress C4070 a solid and lucrative investment for the future.

Sustainability

Konica Minolta promotes sustainable development and integrates environmental and social perspectives into its business strategies. In building your business, you can rely on Konica Minolta products to underpin your green strategy.

Committed to help prevent global warming, Konica Minolta strives to reduce CO₂ emissions during product manufacture, product distribution, at the sales stage, and during product use – with even stricter targets than demanded by the Kyoto Protocol.

Enabling carbon neutrality, Konica Minolta proposes to its customers the offset of unavoidable CO₂ emissions for production printing. Together with the experts from Climate Partner, we offer a new and profound concept for professional production devices.



Controller

Konica Minolta Embedded Controller IC-609)
 Expansion HDD UK-112
 APPE kit UK-220
 VDP kit UK-222*
 Local connection kit EK-612
 Fiery Controller (Server type) IC-317
 Fiery Controller (Embedded type) IC-419
 Video interface kit VI-515

Options for printer body

Original cover OC-511
 Working table WT-511
 Pat-light MK-744C
 IC card authentication AU-201S
 Dehumidifier heater for printer tray HT-511
 Fusing unit for envelope printing EF-107

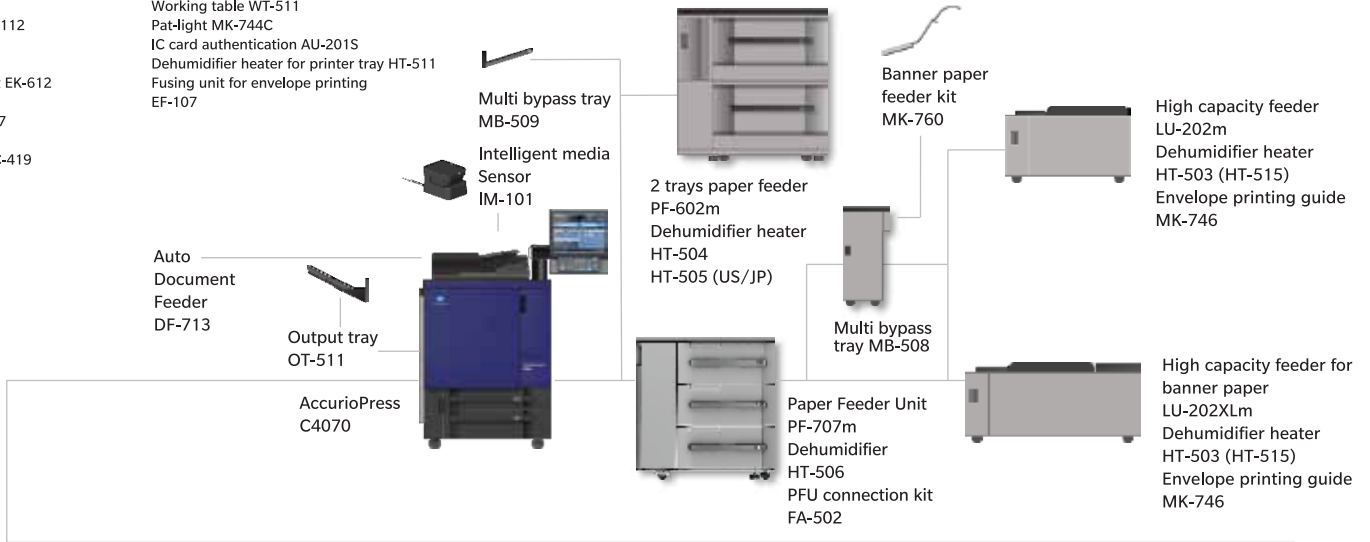

Auto inspection options

Processing unit UK-301
 Video interface VI-515

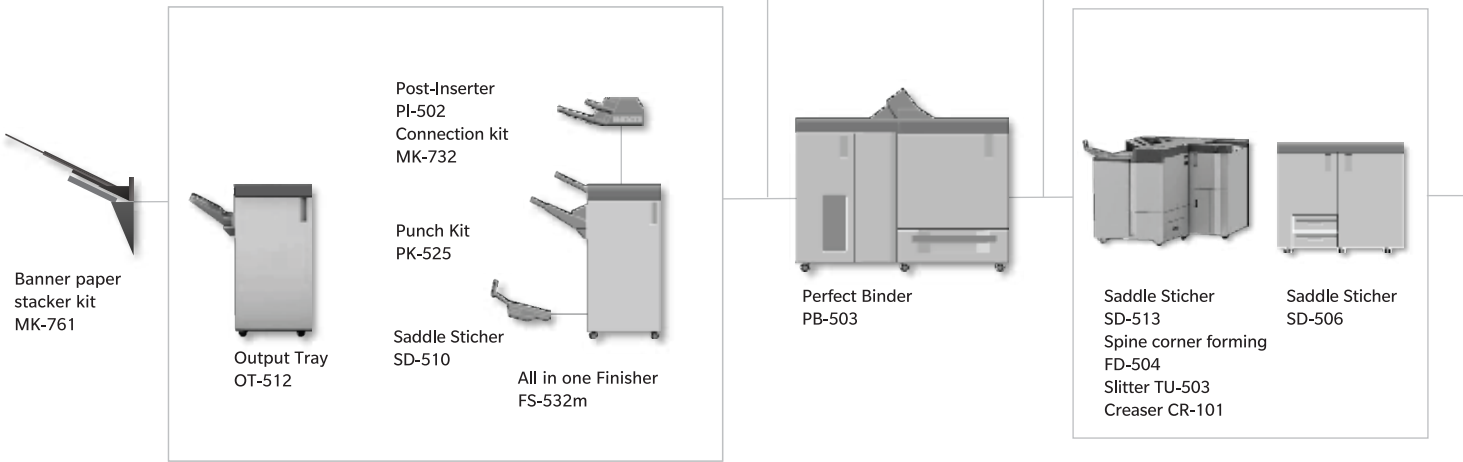
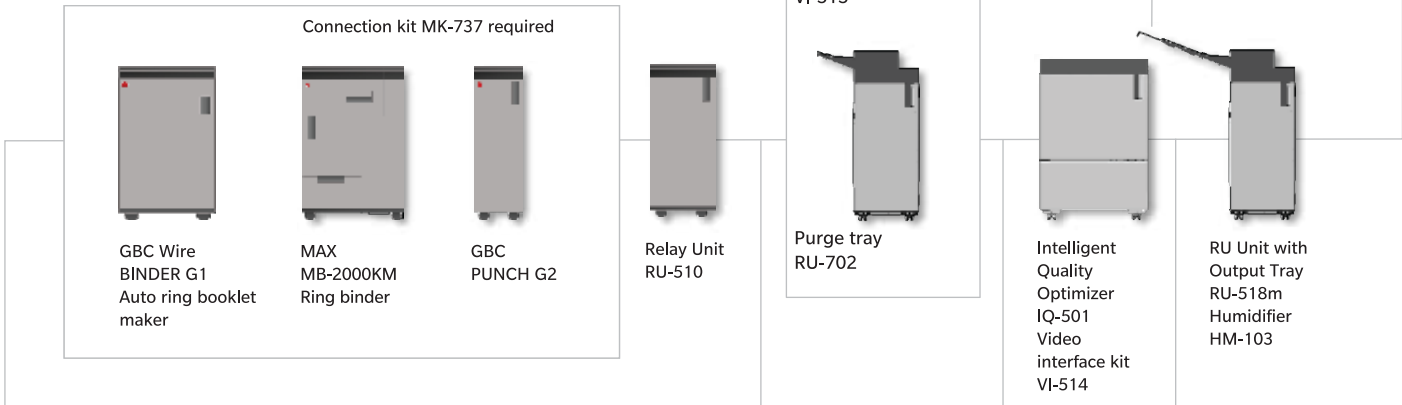



KONICA MINOLTA

TECHNICAL SPECIFICATIONS

RETHINK PRODUCTION PRINTING

AccurioPress C4070

Type	Console
Color availability	color
Paper weight	62 – 360 g/m ²
Paper sizes	330.2 x 487.7 mm 330.2 x 864 mm (max. duplex) 330.2 x 1300 mm (max. simplex)
Paper input	Max.: 15,390 sheets
Scanning resolution	600 dpi x 600 dpi
Writing resolution	Equivalent to 3600 dpi x 2400 dpi
Copy Speed	A4 -Simplex: 71 ppm
	A3 -Simplex: 39 ppm
	217-360 g/m ² 45 A4/26 A3
Gradation	256
Standard Paper Tray Capacity	1500 sheets A4 80 g/m ²
Magnification	25 – 400%, in 0.1% steps
Memory size	24GB (main body:8GB+ IC 609:16GB)
Warm-up Time	390 seconds or less
First Copy/Printing Time (Color/Monochrome)	6.1 seconds or less/ 4.0 seconds or less
Scan speed (A4)	Single-sided 140 opm ^{*3} Duplex 280 opm ^{*1}
Envelope Printing	Standard
Controller CPU-IC 609	Intel Core i5-6500 3.2GHz ^{*1}
Compatible Controllers	IC-609 (KM), IC-317 (EFI), IC-419 (EFI)
Main Unit Size (WxDxH mm) (Recommended configuration)	84.65 x 35.55 x 58.19 inches (2,150 x 903 x 1478 mm) (main unit + DF-713 + LU-202m + FS-532+IC)
Duty Cycle	7,58,000 ^{*2}
Average Monthly Print Volume (optimum volume)	32.5K -130K
Unit weight	312 kg

KONICA MINOLTA IMAGE CONTROLLER IC-609

Architecture	Internal
OS	Linux
CPU	Intel Core i5 6500
Clock speed	3.2 GHz
RAM std	16 GB
HDD	1 TB x 2
Page-description language	PostScript3 (PS PS3020); PDF Ver1.7; TIFF Ver6 compatible; PPML Ver2.2; APPE Ver4.6; PDF/VT ver2
Applicable OS	Windows 8.1/10; Windows Server 2012/R2/2016/2019; Mac OS X 10.11–15

FIERY IMAGE CONTROLLER IC-419

Architecture	Internal
OS	Linux
CPU	Intel Pentium G4400
Clock speed	3.3 GHz
RAM std	8 GB
HDD	500 GB
Page-description language	PostScript3 (CPSI 3020); PDF Ver1.7; APPE Ver5; PCL (5, 6) emulation
Applicable OS	Windows 8.1/10; Windows Server 2012/R2/2016/2019; Mac OS X 10.11–15

FIERY IMAGE CONTROLLER IC-317

Architecture	External
OS	Windows 10
CPU	Intel Core i5-6500
Clock speed	3.2 GHz
RAM std	8 GB
HDD	1 TB
Page-description language	PostScript3 (CPSI 3020); PDF Ver1.7; PPML Ver3.0; APPE Ver5; PDF/VT 2; PCL (5, 6) emulation
Applicable OS	Windows 8.1/10; Windows Server 2012/R2/2016/2019; Mac OS X 10.11–15

- When using KM IC-609
- Peak volume in Q Zone
- When using DF-713, 200 dpi
- All specifications refer to A4-size paper of 80 gsm quality.
- The support and availability of the listed specifications and functionalities varies depending on operating systems, applications and network protocols as well as network and system configurations.
- Some of the product illustrations contain optional accessories.
- Specifications and accessories are based on the information available at the time of printing and are subject to change without notice.
- Konica Minolta does not warrant that any prices or specifications mentioned will be error-free.
- All brand and product names may be registered trademarks or trademarks of their respective holders and are hereby acknowledged.

Product appearance, configuration and/or specifications are subject to change without notice. This product is not available for some countries or regions.

Konica Minolta Business Solutions India Pvt. Ltd.

Building No: 8, Tower-C, 10th Floor, DLF Cyber City, Phase-2, Gurugram, Haryana-122002, India | Board No. +91-124-6652000

URL: www.konicaminolta.in | marcom@bin.konicaminolta.in

Connect with us :